

Shredding Result

paper

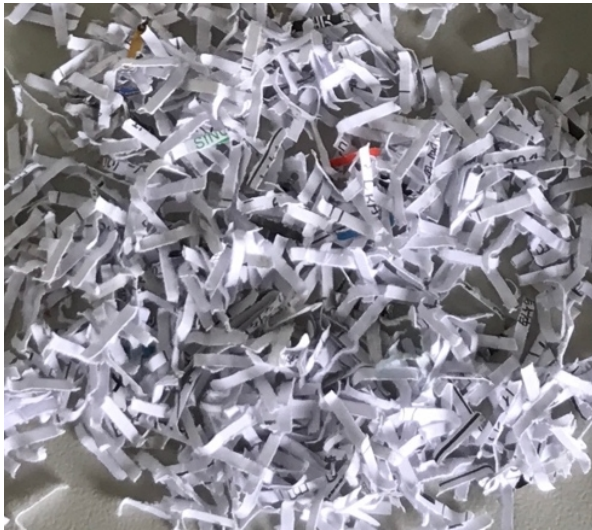

card



Cardboard Boxes



Film / Labels











Wood Fiberboard







Technical Specifications

YD-3120S | YD-3120C | YD-3120M

Model	YD-2760	YD-3120S	YD-3120C	YD-3120M	YD-M2405
 Feed Width (mm)	270mm	310mm	310mm	310mm	220mm
 Cut Size	3.8*38mm	3.8mm or 5.8mm	3.8*38mm	2*8mm	1*2mm
 Max Sheets	20-25	26-32 (or 40)	20-25	15-18	4-5
 Weight (kg)	45kg	45kg	45kg	45kg	45kg
 Power	900W	900W	900W	900W	480W
 Continuous	Yes	Yes	Yes	Yes	60min
 LxWxH (mm)	480*396*706	532*465*910	532*465*910	532*465*910	470*396*706
 Bin(L)	62L	120L	120L	120L	60L

Customization & Purchase Information

-  **Custom Output Sizes**
 - Customizable to various shapes and sizes, such as **0.3 x 0.3 mm** (ultra-fine powder), **0.8 x 3 cm**, or **0.5 x 1 cm** (strips/particles).
-  **Duty Cycle Advice**
 - This model is not recommended for **24/7 continuous 3-shift operations**. For 365-day non-stop production line shredding, we recommend the **YUEDU YD-SSJ Series**.
-  **Standard Bin Capacity**
 - Standardized 120L high-capacity waste bin included.
-  **Maintenance Kit**
 - **1 Bottle** of specialized cutter lubricating oil.
 - **20 Units** of heavy-duty waste collection bags.

 **Website(Global):** www.yuedushredders.com

 **Email:** yuedushredders@gmail.com

 **Phone WhatsApp:** +86 159 0178 2779

YUEDU YD-3120 Series

High-Performance Secure Destruction Shredder with Intelligent Load Control

Advanced Shredding Capabilities

- **Powerful Destruction:** Specifically designed for high-security materials, easily handling thick A4 stacks, bound magazines, and optical media (CDs/DVDs). No need to remove staples or paper clips before shredding.

Intelligent Control & Safety



- **Intelligent Load Panel:** Features a real-time monitoring panel to prevent overloading and ensure optimal motor performance.
- **Smart Energy Management:** Automatic sleep mode during inactivity and auto-sensing technology for effortless operation.
- **Safety Alerts:** Equipped with instant notifications for paper jams and door-open status to protect the operator and the machine.

Application Scenarios

- **Large Corporate Offices**
- **Archive & Record Management Centers**
- **QC & Compliance Departments**
- **Financial & Accounting Offices**

Model YD-3120

✓ Key Features

-  Continuous operation
-  120L BIN



Only for (S/C/M)+

Fn Function button switch below three indicator lights.

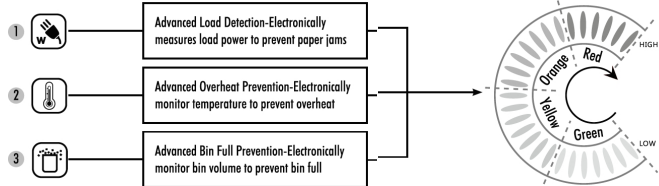

Operation Safety & Large Capacity

Auto-Stop on Door Opening



Large Capacity Bin



Mobility & User-Friendly Design

User-Friendly Operation



Flexible Mobility



Machine Detail View



Feeding



Panel 1



Panel 2



Front



Right 1



Right 3



Front2



Right 2



Back

Three-View Diagram | YD-3120

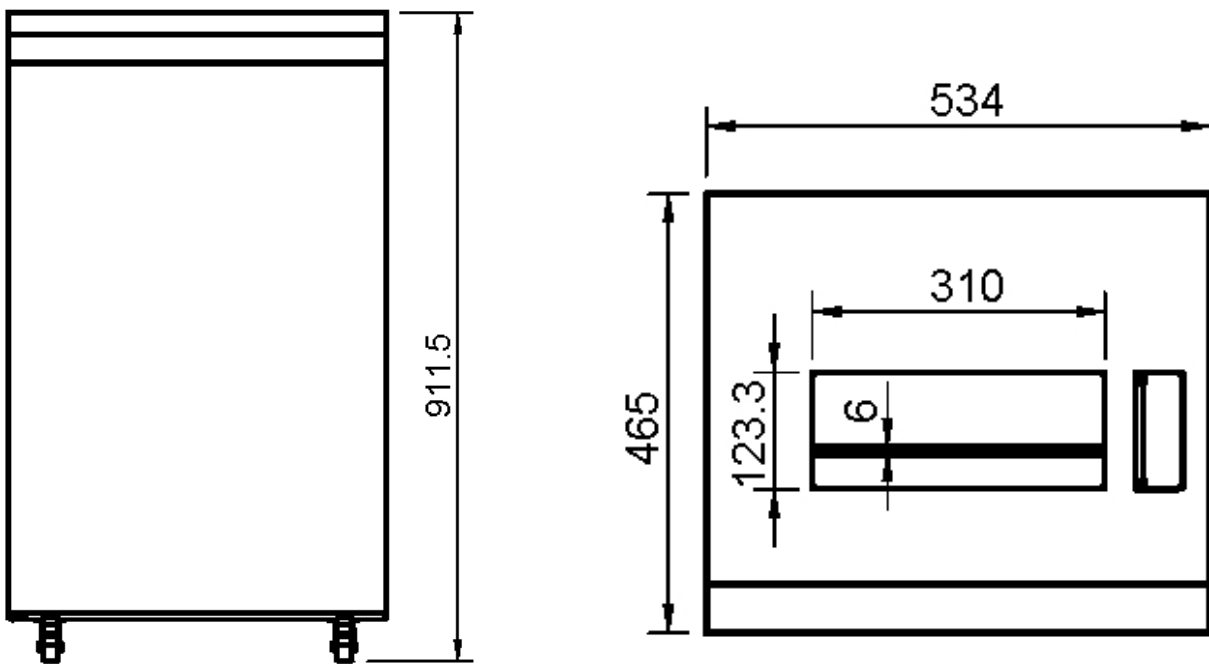

 All dimensions in the 3-view technical drawings are in millimeters (mm).

Packaging & Logistics

Professional Packaging & Logistics | Ensuring Safe Delivery Worldwide

**Pre-shipment
Cleaning**



palletized corrugated box



tri-ply plywood crate



Full Exterior
Polishing &
**Corner and edge
protection
packaging**

Standard Wooden
Pallet & High-
Strength Carton

Fumigation-Free
Plywood Crate
(Standard for
International
Shipping)

- **Exterior Finishing:** Every machine undergoes professional surface cleaning and corner reinforcement to prevent scratches during transit.
- **Domestic Logistics:** Our default domestic packaging includes heavy-duty wooden pallets and reinforced corrugated cartons for secure regional transport.
- **Export Standards:** For global orders, we use **Fumigation-Free Plywood Crates** that comply with international shipping regulations, ensuring hassle-free customs clearance and maximum protection.

Packaging Standards & Customization Notes

- **Domestic Orders (Standard):** Default packaging for domestic shipments is included.
- **Export Requirements (Optional):** If you require **International Export Wooden Crate Packaging**, please contact our customer service team to calculate the additional costs for the specialized crates.

Business License (Official Chinese & English Translation)



Business License (Translated Version)

Shanghai Yuedu Technology Co., Ltd.

◆ Company Information

Company Name:

Shanghai Yuedu Technology Co., Ltd.

Unified Social Credit Code:

91310114MA1GUXHQ8H

Company Type:

Limited Liability Company (Invested or Controlled by Natural Persons)

Registered Address:

Room 17239, Building 2, No. 4268 Zhen'nan Road, Jiading District, Shanghai, China

Legal Representative:

Deng Hao

Registered Capital:

RMB 3,700,000

◆ Registration Details

Date of Establishment:

September 5, 2018

Business Term:

From September 5, 2018 to September 4, 2048

◆ Registration Authority

Shanghai Jiading District Administration for Market Regulation

Date of Issue:

September 5, 2018



This document is a translated version of the original Chinese business license.

In case of any discrepancy, the original Chinese version shall prevail.

- ✓ Registered and verified company in China
- ✓ Officially issued by Chinese government authority
- ✓ Valid for international business cooperation

🌐 **Website(Global):** www.yuedushredders.com

✉ **Email:** yuedushredders@gmail.com

☎ **Phone WhatsApp:** +86 159 0178 2779

Contact Us

Johnny Deng, Managing Director

 Phone: +86 159 0178 2779 (WhatsApp / WeChat / Facebook / Telegram)

 Email: denghao8410@gmail.com

Shanghai YUEDU Technology Co., Ltd. (YUEDU Shredders)

 **Website(Global):** www.yuedushredders.com

 **Email:** yuedushredders@gmail.com / denghao8410@gmail.com

 **Sales Supervisor:** +86 159 0178 2779 (WhatsApp / WeChat / Facebook / Telegram)

 **Administrative Supervisor:** +86 137 6138 5116

 **Head Office Main Line:** +86 21 519 000 20

 **Company Headquarters:** Building 12, No. 555 Chengyin Road, Baoshan City Industrial Park, Shanghai, China

About YUEDE Shredders

Shanghai YUEDU Technology Co., Ltd. is a **Shanghai-certified high-tech enterprise** specializing in the development and manufacturing of **shredding and destruction equipment**. We serve a wide range of sectors including **government agencies, financial institutions, military departments, enterprises, and recycling industries**.

Our offerings include **office and industrial-grade paper shredders, hard drive destroyers, plastic crushing systems, and fully customized destruction center solutions**. From design to delivery, we help clients achieve efficient, secure, and compliant material destruction.

Our Mission

We are dedicated to the shredding and destruction industry, continuously solving diverse material shredding and disposal challenges for our clients around the world.

 **Website(Global):** www.yuedushredders.com

 **Email:** yuedushredders@gmail.com

 **Phone WhatsApp:** +86 159 0178 2779